

IAME

Parilla

X30 125cc RL - TaG



OVERHAUL MANUAL



INDEX

	<u>Page</u>
1. - PARILLA X30 125cc RL – TaG ENGINE DISASSEMBY	1
2. - CRANKSHAFT DISASSEMBLY/ ASSEMBLY	10
2.1- CRANKSHAFT DISASSEMBLY	10
2.2- CRANKSHAFT ASSEMBLY	12
3. - PARILLA X30 125cc RL – TaG ENGINE ASSEMBLY	15

ATTACHMENTS

- FASTENER TORQUE VALUES
- CROSS PATTERN LOCKING ORDER ON CRANKCASE
- MAIN PRESCRIPTIONS
- CON-ROD BIG AND SMALL END BEARING TOLERANCES
- GEAR INSTALLATION - RECOMMENDATIONS
- LIST OF OVERHAUL TOOLS
- Table for wear evaluation on Bearings/ Halfcrankshafts
- BENCH ENGINE FIXING TOOL – Drawing

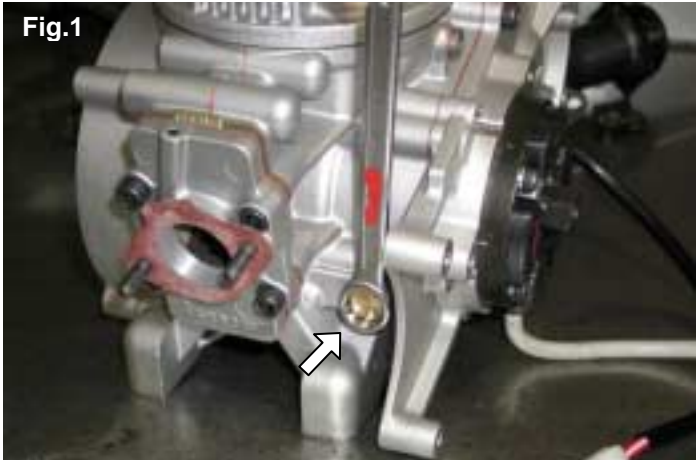
1 – X30 125cc RL – TaG ENGINE DISASSEMBLY

<u>OPERATIONS</u>	<u>PICTURES</u>
<p>1. <u>DISCHARGE OIL FROM THE ENGINE</u></p> <ul style="list-style-type: none"> - UNSCREW THE OIL LEVEL PLUG (see Fig.1). <p style="margin-left: 20px;">(14mm socket wrench)</p> <ul style="list-style-type: none"> - TILT THE ENGINE TO DISCHARGE OIL (see Fig.2). 	<p>Fig.1</p>  <p>Fig.2</p> 
<p>2. <u>FIX THE ENGINE ON THE BENCH VICE</u></p> <ul style="list-style-type: none"> - SCREW ON N°2 SCREWS M8x60 ON THE CRANKCASE 	<p>BENCH TOOL (see attached drawing)</p>
<p>3. <u>REMOVE THE EXHAUST HEADER</u></p> <ul style="list-style-type: none"> - UNSCREW N°2 NUTS M8 (see Fig. 3). <p style="margin-left: 20px;">(13mm SOCKET WRENCH)</p> <ul style="list-style-type: none"> - REMOVE N°2 WASHERS - REMOVE THE EXHAUST GASKET 	<p>Fig.3</p> 

4. REMOVE THE IGNITION

- REMOVE THE STATOR
UNSCREW N°4 ALLEN SCREWS M5x25 (see Fig.4)



(4mm ALLEN WRENCH - T TYPE)

- REMOVE SPARKPLUG AND INSTALL THE
THE PISTON FITTING (P.N. 10271) TO
PREVENT THE CRANKSHAFT FROM
TURNING (see Fig.5).

- REMOVE THE NUT M10 AND WASHER
(see Fig.6).



(17mm SOCKET WRENCH)

- EXTRACT THE ROTOR (see Fig.7).
(USE A SCREWDRIVER IF NECESSARY)

REMOVE KEY FROM SHAFT



5. **REMOVE THE GEAR BOX COVER**

- UNSCREW N°7 ALLEN SCREWS M6x16 (see Fig.8).

(5mm ALLEN WRENCH - T TYPE)

- REMOVE COVER AND WASHER (USE A PLASTIC MALLET IF NECESSARY) (see Fig.9).

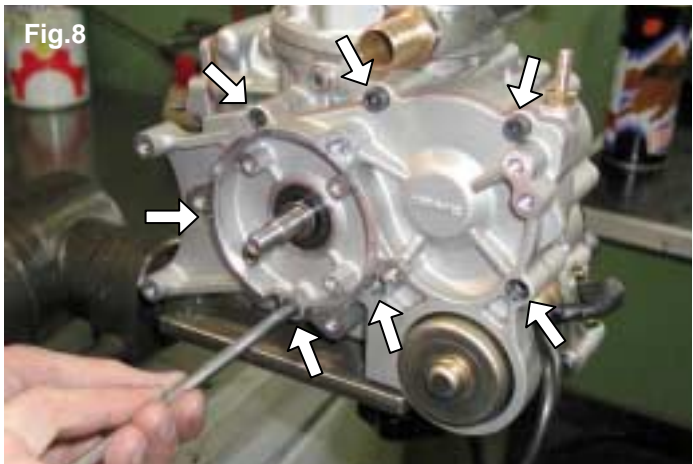

6. **REMOVE GEARS**

- REMOVE RETAINING RINGS FROM THE CRANKSHAFT AND BALANCE SHAFT (see Fig.10).

(PLIERS FOR RETAINING RINGS)

- REMOVE GEAR ON THE CRANKSHAFT (see Fig.11).

⚠ ATTENTION:
MARK THE GEAR FOR IDENTIFICATION WHEN REASSEMBLING

NOTE:
IN THE ENGINES MNUFACTURED AFTER SEPTEMBER '05. THE FIXING OF THE GEAR ON THE CRANKSHAFT IS MADE BY A SPACER WITH AN "OR" WHICH IS PUSHED AGAINST GEAR BY THE IGNITION ROTOR (see drawing).



- REMOVE GEAR FROM THE BALANCE SHAFT
(see Fig.12).
(USE A SCREWDRIVER IF NECESSARY) .



Fig.12

7. **REMOVE ELECTRIC STARTER**

- UNSCREW N°2 ALLEN SCREWS M6x35
(see Fig.13).



(5mm ALLEN WRENCH – T TYPE)

- REMOVE STARTER (see Fig.14).

NOTE:
IN THE ENGINES MNUFACTURED AFTER
SEPTEMBER '05. THE STARTER CAN ALSO
BE REMOVED WITHOUT TAKING AWAY
THE GEARS COVER BUT SIMPLY BY
REMOVING THE CLAMP OF THE COVER
(see drawing).

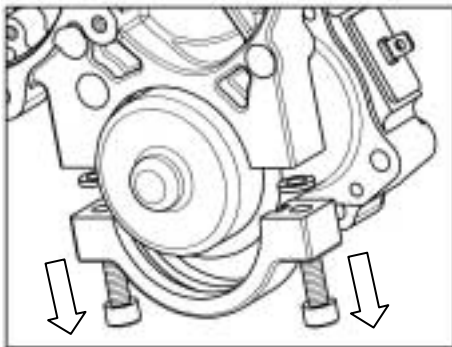

Fig.13

Fig.14



8. **REMOVE CLUTCH**

- DISCONNECT THE GROUND CABLE FROM
THE CRANKCASE
UNSCREW THE ALLEN SCREW M6x12
(see Fig.15).



(5mm ALLEN WRENCH-T TYPE)



Fig.15

- REMOVE CLUTCH COVER
UNSCREW N°3 ALLEN SCREWS M6x25
(see Fig. 16).

(5mm ALLEN WRENCH – T TYPE)



- REMOVE THE LOCKING NUT M10 FROM
CLUTCH DRUM (see Fig.17).

(17mm SOCKET WRENCH)

NOTE:
MAKE SURE THAT THE PISTON STOP TOOL
IS INSTALLED (P.N. 10271)

- REMOVE OUTER WASHER, CLUTCH
DRUM, ROLLER CAGE AND INNER
WASHER



- REMOVE THE PISTON STOP TOOL
AND WITH THE CLUTCH LOCKING
WRENCH (P.N. 10270), REMOVE THE
LOCKING NUT M20 FROM CLUTCH BODY
(see Fig.18).

(30 mm HEXAGON RING WRENCH)



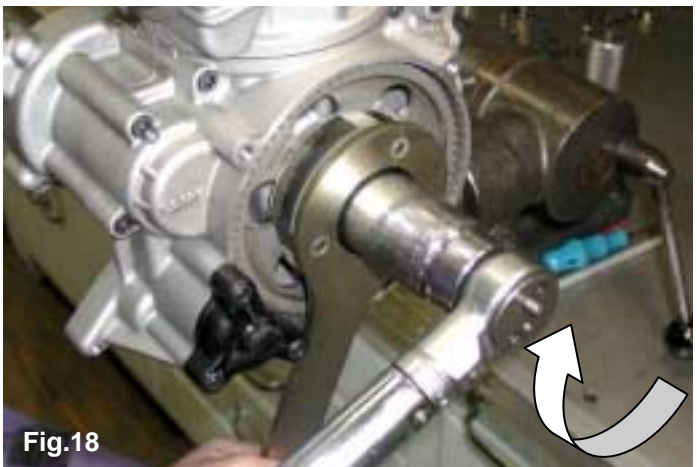



! ATTENTION:
TURN CLOCKWISE AS NUT HAS LEFT
THREAD.





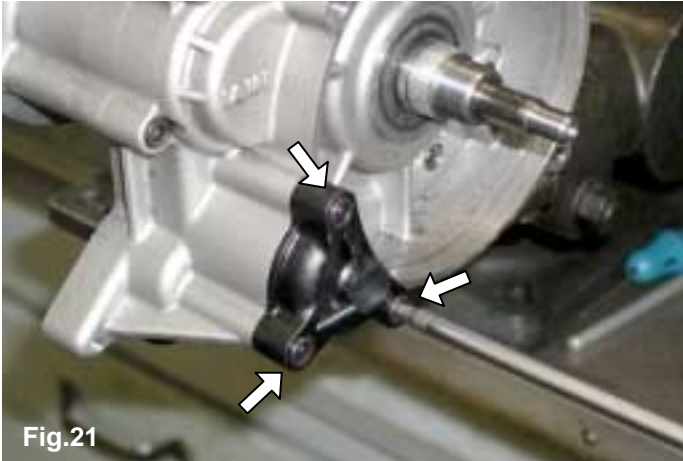







- REMOVE CLUTCH BODY AND STARTING
RING FROM THE CRANKSHAFT WITH THE
CLUTCH DISASSEMBLY TOOL
(P.N. 10272-C) (see Fig.19).



(12mm ALLEN WRENCH
(27mm WRENCH)

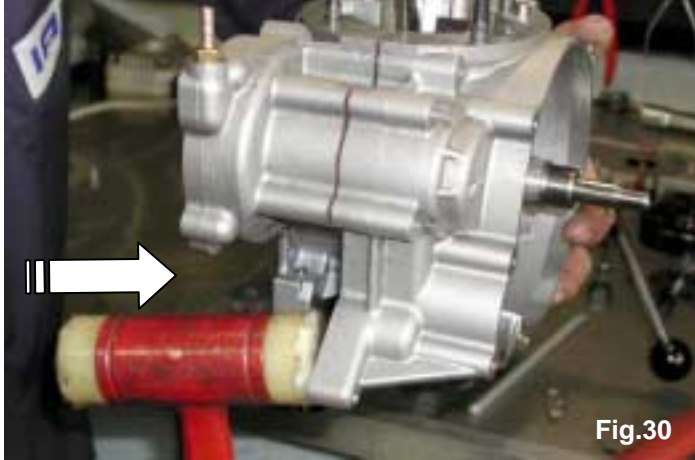

	<p>- REMOVE STARTING RING FROM CLUTCH BODY UNSCREW N°3 SCREWS M6x12 (see Fig.20).</p> <p>(10mm SOCKET WRENCH)</p>	 <p>Fig.20</p>
<p>9.</p> 	<p><u>REMOVE STARTER COUNTERSHAFT</u></p> <p>- REMOVE STARTER COUNTERSHAFT COVER UNSCREW N°3 ALLEN SCREWS M6x25 (see Fig.21).</p> <p>(5mm ALLEN WRENCH – T TYPE)</p> <p>- EXTRACT STARTER COUNTERSHAFT (see Fig.22).</p>	 <p>Fig.21</p>  <p>Fig.22</p>
	<p>10. <u>REMOVE CARB. INLET CONVEYOR</u></p> <p>- UNSCREW N°4 ALLEN SCREWS M6x25 (see Fig.23).</p> <p>(5mm ALLEN WRENCH –T TYPE)</p> <p>- REMOVE OUTER GASKET FROM CONVEYOR</p>	 <p>Fig.23</p>

<ul style="list-style-type: none"> - REMOVE REED GROUP (see Fig.24). - REMOVE INNER WASHER FROM REED GROUP 	 <p style="text-align: right;">Fig.24</p>
<p>11. REMOVE CYLINDER HEAD</p> <ul style="list-style-type: none"> - UNLOOSE N°4 NUTS M8 BY HALF TURN (CROSS PATTERN DISASSEMBLY), REMOVE NUTS (see Fig.25). <p>(13mm HEXAGON RING WRENCH)</p> <ul style="list-style-type: none"> - REMOVE WASHERS 	 <p style="text-align: right;">Fig.25</p>
<p>12. REMOVE CYLINDER (see Fig.26).</p> <ul style="list-style-type: none"> - REMOVE CYLINDER BASE GASKET 	 <p style="text-align: right;">Fig.26</p>
<p>13. REMOVE PISTON</p> <ul style="list-style-type: none"> - REMOVE CIRCLIPS FROM PISTON (see Fig.27). <p>(SCREWDRIVER WITH ROUND EDGES)</p> <p>⚠ ATTENTION: DO NOT SCRATCH PISTON AND CIRCLIP SEATS.</p>	 <p style="text-align: right;">Fig.27</p>

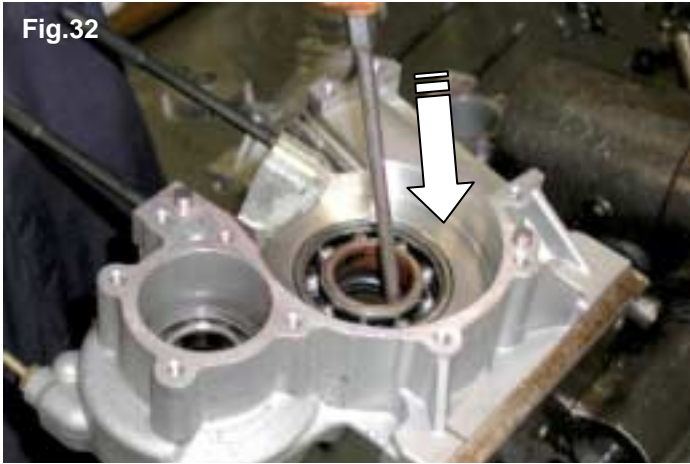
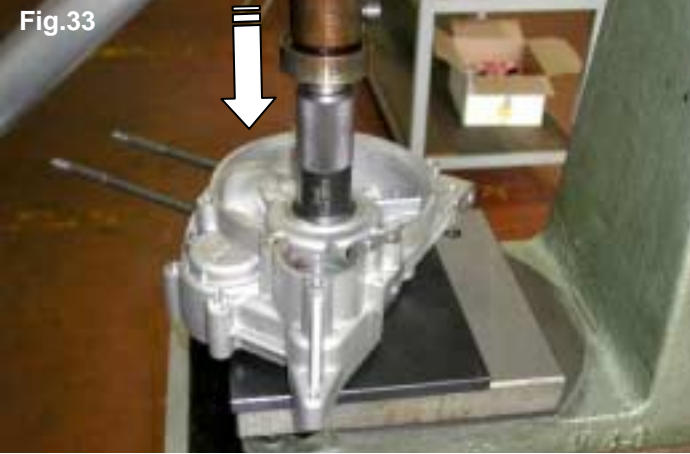
	<ul style="list-style-type: none"> - REMOVE PISTON PIN WITH SPECIAL PISTON PUNCH (P.N. 10200) (see Fig.28). - REMOVE PISTON - REMOVE ROLLER CAGE 	<p>Fig.28</p> 
<p>14.</p>  	<p><u>OPEN CRANKCASE</u></p> <ul style="list-style-type: none"> - UNSCREW N°10 ALLEN SCREWS M6x45 (see Fig.29). (5mm ALLEN WRENCH – T TYPE) - OPEN CRANKCASE WITH A PLASTIC MALLET (see Fig.30). (PREVENT THE CRANKSHAFT FROM FALLING) 	<p>Fig.29</p>   <p style="text-align: right;">Fig.30</p>
<p>15.</p>	<p><u>REMOVE CRANKSHAFT AND BALANCE SHAFT</u> (see Fig.31).</p>	<p>Fig.31</p> 

<p>16. REMOVE OIL SEALS (USE A SCREWDRIVER) (see Fig.32).</p>	 <p>Fig.32</p>
<p>17. REMOVE BEARINGS (IF NECESSARY)</p> <p>CHECK THE INNER DIAMETER OF BEARINGS, ON DIFFERENT POINTS. REFER TO THE ATTACHED TABLE TO CHECK BEARING WEAR STATUS.</p> <p>- REMOVE BEARINGS FROM CRANKSHAFT WITH THE SPECIAL TOOL (P.N. 10291) (see Fig.33).</p> <p>REMOVE BEARING SPACERS (0.10 / 0.15)</p> <p>- REMOVE BALANCE SHAFT OUTER BEARING (GEAR SIDE)</p> <p>UNSCREW THE BEARING RETAINING SCREW M5x10 (see Fig.34).</p> <p>(4mm ALLEN WRENCH – T TYPE)</p> <p>REMOVE BEARING WITH SPECIAL TOOL (P.N. 10293) (see Fig.35).</p>	 <p>Fig.33</p>  <p>Fig.34</p>  <p>Fig.35</p>

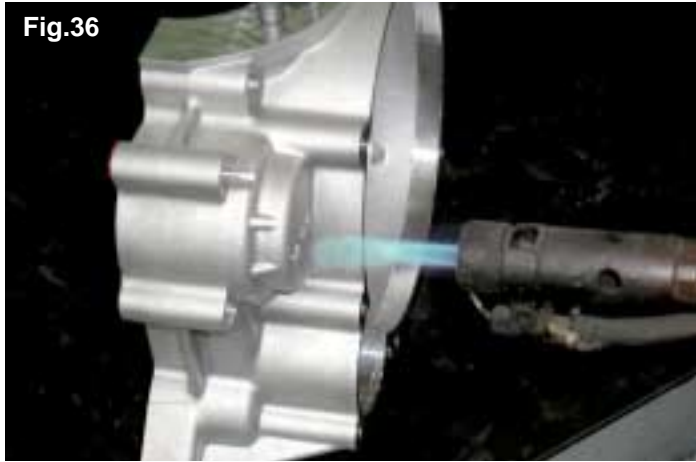
<p>- REMOVE INTERNAL BEARING FROM BALANCE SHAFT</p> <p>HEAT BEARING SEAT EXTERNALLY WITH A BLOWPIPE (see Fig.36).</p> <p>⚠ ATTENTION: <u>CAREFULLY DEGREASE THE SURFACES NEAR THE BEARING BEFORE HEATING</u></p> <p>ONCE THE PROPER TEMPERATURE IS REACHED, REMOVE BEARING KNOCKING THE HALFCRANKCASE ON THE WORKING BENCH.</p>	 <p>Fig.36</p>
---	---

2 – CRANKSHAFT ASSEMBLY/DISASSEMBLY

⚠ ATTENTION:
THE ASSEMBLY/DISASSEMBLY OPERATIONS ON THE ENGINE CRANKSHAFT, MUST BE PERFORMED ONLY BY AN AUTHORIZED SERVICE CENTER USING THE SPECIALLY DESIGNED TOOLS. USE OF UNFITTED TOOLS OR OPERATIONS PERFORMED BY UNSKILLED PERSONNEL MAY DAMAGE THE CRANKSHAFT BEYOND REPAIR.

DESCRIPTION	P.N.
CRANKSHAFT ASSEMBLY KIT	10110B-C
CRANKPIN BUSH (INCLUDED IN 10110B-C)	10150A
CRANKSHAFT DISASSEMBLY KIT INCLUDES:	10100A-C2
CRANKSHAFT SUPPORT	10100
CRANKSHAFT PLATE	10104A
CRANKSHAFT INSERT	10106
CRANKPIN PUSHER	10107

2.1 – CRANKSHAFT DISASSEMBLY



OPERATIONS	PICTURES
<p>1. PLACE THE DISASSEMBLY TOOL (P.N. 10100A-C2) UNDER THE PRESS (PRESS 5 MeT).</p>	 <p>Fig.1</p>
<p>2. PLACE THE CRANSHAFT IN THE TOOL BY INSERTING THE CRANKSHAFT PLATE (P.N. 10104A) BETWEEN THE CRANKSHAFT HALVES (see Fig.1).</p>	



<p>3. INSERT THE CRANKSHAFT INSERT (P.N. 10106) AND USING THE CRANKPIN PUSHER (P.N. 10107) PRESS THE CRANKPIN OUT (vedi Fig.2).</p>	 <p style="text-align: right;">Fig.2</p>
<p>4. DISASSEMBLE THE COMPLETE CON-ROD WITH WASHERS. REPEAT THE OPERATIONS TO EXTRACT THE CRANKPIN FROM THE OTHER HALF CRANKSHAFT (see Fig.3).</p>	 <p style="text-align: right;">Fig.3</p>

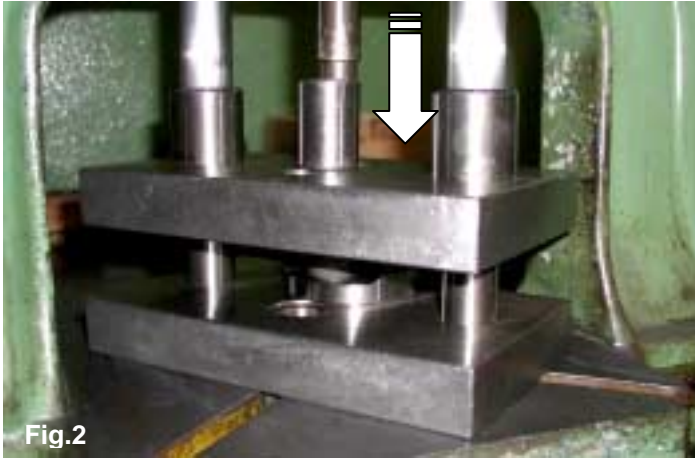

BEFORE REASSEMBLING, WASH ALL PARTS WITH KEROSENE

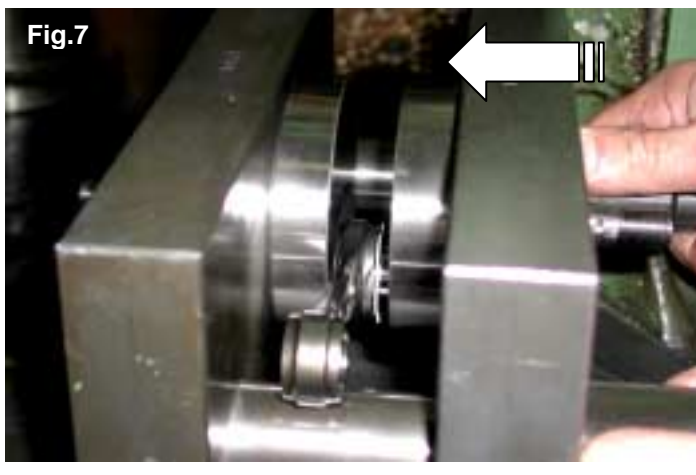

<p>a) CHECK STATUS OF CON-ROD (TOP AND BOTTOM). IF OVALIZATION EXCEEDS 0.01mm, REPLACE CON-ROD.</p>	<p>- 0.01 CENTESIMAL MICROMETER (21/50) - 0.001 BORE GAUGE WITH CHECK RING Ø26 AND Ø18</p>
<p>b) CHECK STATUS OF CRANKPIN VISUAL CHECK – REPLACE IF NECESSARY <u>REPLACE AFTER 30 WORKING HRS.</u></p>	
<p>c) CHECK STATUS OF CAGE (BIG END) VISUAL CHECK – REPLACE IF NECESSARY <u>REPLACE AFTER 30 WORKING HRS.</u></p>	
<p>d) CHECK STATUS OF CRANKSHAFT HALVES. CHECK BEARING SEATS IN DIFFERENT POINTS. REFER TO THE ATTACHED TABLE TO CHECK THE WEAR STATUS OF THE CRANKSHAFT HALVES.</p>	
<p>e) CHECK STATUS OF SILVER SHIMS VISUAL CHECK – REPLACE IF NECESSARY .</p>	
<p>FOLLOW ATTACHED TABLE FOR MAX. MATCHING PLAY</p>	

2.2 – CRANKSHAFT ASSEMBLY OPERATIONS

	<u>OPERATIONS</u>	<u>PICTURES</u>
1.	PLACE THE CRANKSHAFT ASSEMBLY TOOL (P.N. 10110B-C) UNDER THE PRESS, VERTICALLY (PRESS 5 MeT).	
2.	PLACE THE CRANKSHAFT TOOL INTO THE ASSEMBLY TOOL.	
3.	OIL CRANKPIN HOLE ON CRANKSHAFT HALF.	
4.	PLACE CRANKPIN WITH CRANKPIN BUSH (P.N. 10150A) ON CRANKSHAFT HALF (see Fig.1).	 <p style="text-align: right;">Fig.1</p>
5.	BRING UPPER PLATE OF TOOL IN CONTACT WITH CRANKPIN (see Fig.2).	 <p style="text-align: right;">Fig.2</p>
6.	PROGRESSIVELY PRESS UNTIL CRANKPIN IS COMPLETELY DRIVEN IN (see Fig.3).	 <p style="text-align: right;">Fig.3</p>

<p>7.</p>	<p>EXTRACT BUSH FROM CRANKPIN AND PUT TOOL IN HORIZONTAL POSITION (see Fig.4).</p>	 <p>Fig.4</p>
<p>8.</p>	<p>OIL CRANKPIN AND INSTALL:</p> <ul style="list-style-type: none"> -SILVER SHIM -CON-ROD WITH ROLLER CAGE -SILVER SHIM <p>(see Fig.5).</p> <p>⚠ ATTENTION: <u>ROLLERS ARE FREE IN THE CAGE.</u> <u>PREVENT THEM FROM FALLING.</u> <u>WHEN INSERTING THE CAGE ON THE CRANKPIN.</u></p>	 <p>Fig.5</p>
<p>9.</p>	<p>PLACE THE SECOND CRANKSHAFT IN THE SEAT OF THE COUNTERPLATE (see Fig.6).</p>	 <p>Fig.6</p>
<p>10.</p>	<p>BRING THE 2 PLATES CLOSE UNTIL THE TOOL IS HAND PRESSED (see Fig.7).</p>	 <p>Fig.7</p>

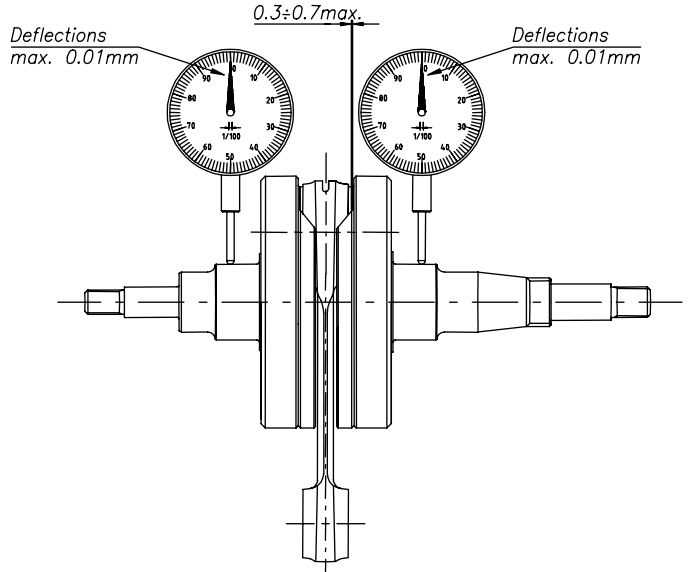
11.	OIL CRANKPIN AND CRANKPIN HOLE ON CRANKSHAFT HALF.	
12.	PUT TOOL IN VERTICAL POSITION (see Fig.8).	 <p>Fig.8</p>
13.	PROGRESSIVELY PRESS THE TWO CRANKSHAFT HALVES TOGETHER.	
14.	OPEN THE TOOL, PUT IT IN HORIZONTAL POSITION AND EXTRACT CRANKSHAFT.	
15.	CHECK THE AXIAL PLAY OF THE CON-ROD (see Fig. 9). IT MUST BE MIN. 0.3mm / MAX. 0.7mm. IF PLAY IS HIGHER OR LOWER, REBUILD THE CRANKSHAFT.	 <p>Fig.9</p>
<i>AFTER ASSEMBLING THE CRANKSHAFT, IT MUST BE ALIGNED. OTHERWISE EXCESSIVE VIBRATIONS, HARD STARTING OR POOR ACCELERATION WILL RESULT.</i>		
a.	PLACE THE CRANKSHAFT BETWEEN THE CENTERS, WITH DIAL INDICATORS READING ON FRONT AND REAR BEARING JOURNALS (see Fig.10). (CENTERS WITH CENTESIMAL DIAL GAUGES AND COPPER HAMMER FOR ALIGNMENT).	 <p>Fig.10</p>

<p>b.</p>	<p>ROTATE CRANKSHAFT AND LOOK AT DEFLECTION OF GAUGE NEEDLES THE DEFLECTION MUST BE, AFTER CENTERING, MAX. 0.01mm (see drawing).</p>	
<p>c.</p>	<p>ADJUST ALIGNMENT WITH A COPPER HAMMER, IF NECESSARY (see Fig.11).</p>	 <p style="text-align: right;">Fig.11</p>

3 -X30 125cc RL - TaG ENGINE ASSEMBLY
BEFORE REASSEMBLING, WASH ALL PARTS WITH KEROSENE

	<u>OPERATIONS</u>	<u>PICTURES</u>
<p>1.</p>	<p><u>INSTALLING BEARINGS</u></p> <ul style="list-style-type: none"> - PLACE THE CRANKCASE HALVES UNDER THE PRESS. - INSERT BEARING SHIMS (AVAILABLE SIZES 0.10 / 0.15 / 0.20) (see Fig.1). 	 <p style="text-align: left;">Fig.1</p>

- **INSERT CRANKSHAFT BEARINGS; BALLS TO BE ON UPPER SIDE VISIBLE DURING THE ASSEMBLY**
(see Fig. 2).
OIL BEARINGS AND BEARING SEATS OUTSIDE.



Fig.2

USE TOOL TO INSERT THE BEARINGS
(P.N. 10290)
(see Fig.3).

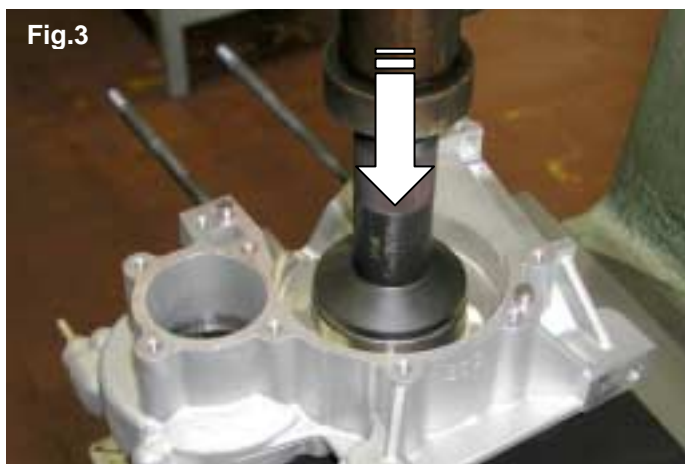

Fig.3

- **INSTALL INNER BALANCE SHAFT BEARING; BEARING BALLS TO BE ON UPPER SIDE.**

(OIL BEARING BALLS BEFORE INSTALLATION) .

OIL BEARINGS AND HALFCRANKCASE SEATS.
USE THE SPECIAL TOOL TO ASSEMBLE
(P.N. 10292) BEARINGS
(see Fig.4).



Fig.4

- **INSTALL OUTER BALANCE SHAFT BEARING (GEAR SIDE); BEARING BALLS TO BE ON UPPER SIDE.**

OIL BEARINGS AND HALFCRANKCASE SEATS .

USE SPECIAL TOOL (P.N. 10293)
TO INSERT BEARING (see Fig.5).



Fig.5



 - INSTALL THE BEARING RETAINING SCREW M5x10 (see Fig.6). Allen. TORQUE AT $6 \div 8$ Nm ($50 \div 70$ in-lb).
 (4mm ALLEN WRENCH – T TYPE)

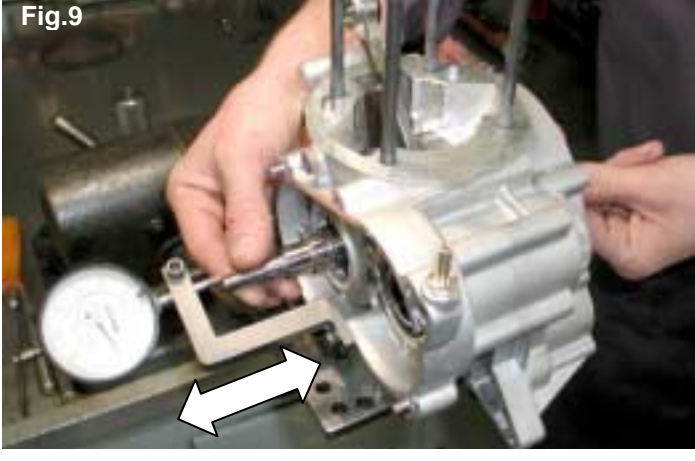

2. CRANKCASE ASSEMBLY
 - INSERT CRANKSHAFT AFTER OILING THE CRANKSHAFT SEAT IN THE CRANKCASE AND THE BEARING BALLS. THE CRANKSHAFT MUST BE IN SAME POSITION AS IN ORIGINAL INSTALLATION (see Fig.7).

 - ASSEMBLE CRANKCASE HALVES
 N°10 ALLEN SCREWS M6x45 (see Fig.8). (CROSS PATTERN ASSEMBLY – SEE ATTACHED DRAWING). TORQUE AT $8 \div 10$ Nm ($70 \div 90$ in-lb)

 (5mm ALLEN WRENCH – T TYPE)



ATTENTION:
AS FIRST STEP ASSEMBLE CRANKCASE WITH 4 SCREWS AND CHECK CRANKSHAFT AXIAL PLAY TO BE 0.20 ± 0.05 mm.
IF PLAY IS LOWER OR HIGHER DISASSEMBLE CRANKCASE, EXTRACT BEARINGS AND USE DIFFERENT STEEL SHIMS (0.10/0.15/0.20) TO RECOVER PLAY. SHIMS MUST BE EQUALLY POSITIONED (see Fig. 9).

BEFORE FINAL ASSEMBLING OF CRANKCASE HALVES APPLY FLUID GASKET (Motorseal or equivalent) ON CRANKCASE HALVES.
CLEAN EVENTUAL EXCESS OF PRODUCT (see Fig.10).

- OIL CRANKSHAFT AND BEARING BALLS SEATS BEFORE ASSEMBLING (see Fig.11).

- INSERT THE CRANKSHAFT AND BALANCE SHAFT.
CLOSE THE CRANKCASE HALVES (see Fig.12).



3. INSTALLING SEALS

- APPLY SPECIAL LUBRICANT ON SEAL LIPS (see Fig.13).

⚠ ATTENTION:
WHEN INSTALLING NEW SEALS, TURNING THE CRANKSHAFT SHOULD RESULT MORE DIFFICULT, BUT THIS IS NORMAL.



- INSTALL SEAL (GEAR SIDE) WITH SPECIAL TOOL WITH BUSH TO BE INSERTED ON THE CRANKSHAFT (P.N. 10295A) (see Fig.14). (MARK ON SEAL TO BE OUTSIDE).

Fig.14

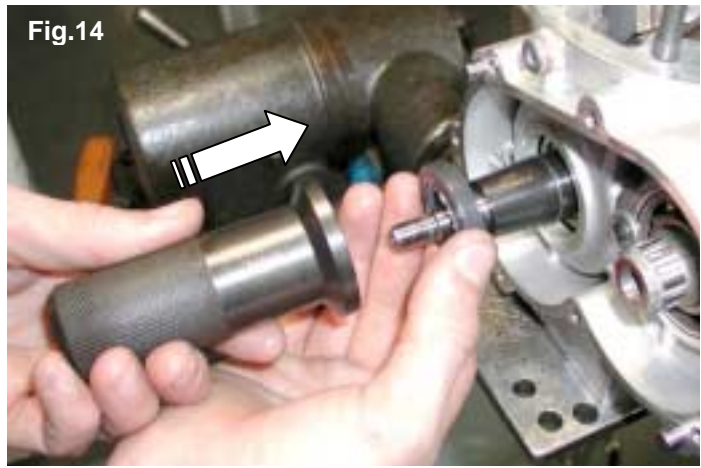

- INSTALL SEAL (CLUTCH SIDE) USING THE SPECIAL TOOL (P.N. 10295A) (see Fig.15). (MARK ON SEAL TO BE OUTSIDE).

Fig.15

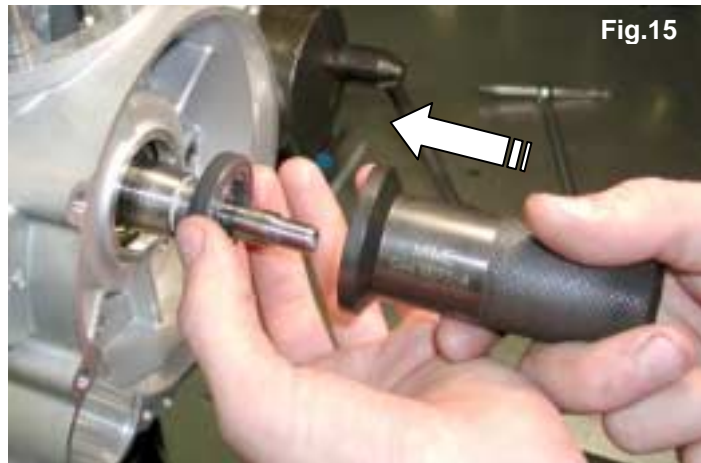

- INSERT SEAL IN GEAR COVER USING THE SPECIAL TOOL (P.N. 10296) (see Fig.16). (MARK ON SEAL TO BE OUTSIDE).



! **ATTENTION:**
OIL SEALS MUST ALWAYS BE REPLACED
WHEN DISASSEMBLED.

Fig.16





4. **INSTALLING GEARS**

- CHECK THE GOOD STATUS OF TEETH ON THE GEAR.
INSTALL GEAR ON THE BALANCE SHAFT (LETTER "C" TO BE VISIBLE) BEING CAREFUL TO ALIGN THE REFERENCE NOTCHES ON THE INTERNAL TEETH (WITH THE HELP OF A PLASTIC HAMMER). (see Fig.17).

! **ATTENTION:**
IF GEARS ARE NOT PROPERLY INSTALLED,
THE DAMPING VIBRATIONS SYSTEM WILL
BE INEFFICIENT.

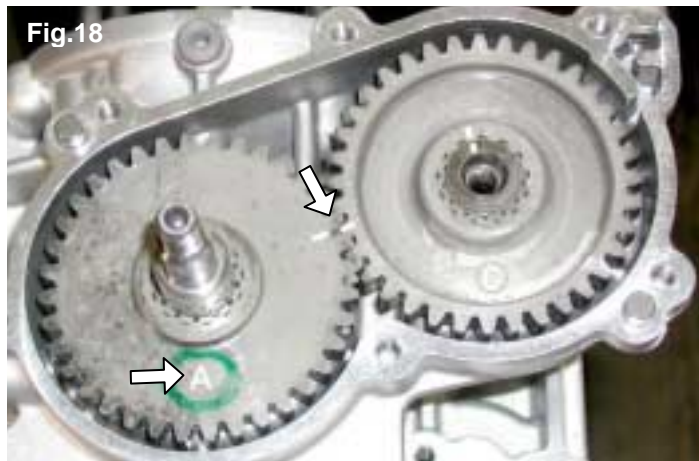
Fig.17



<p>- INSTALL GEAR ON THE CRANKSHAFT (LETTER "A" TO BE VISIBLE) ALIGNING THE REFERENCE NOTCHES ON THE INTERNAL TEETH WITH REFERENCE NOTCHES ON THE EXTERNAL TEETH OF THE 2 GEARS (CHECK BOTH GEARS TO BE ON THE SAME LEVEL). (see Fig.18).</p> <p>NOTE: <u>IF GEARS HAVE NOT BEEN REPLACED, REINSTALL THEM IN THEIR ORIGINAL POSITION. (IDENTIFY THE GEAR MARKED DURING THE DISASSEMBLING AND ASSEMBLE IT ON CRANKSHAFT).</u></p> <p>- INSTALL SEEGER ON THE CRANKSHAFT AND BALANCE SHAFT (see Fig.19).</p> <p> (PLIERS FOR RETAINING RINGS)</p> <p>FOLLOW THE RECOMMENDATIONS AS PER ATTACHMENT.</p> <p>NOTE: <u>IN THE ENGINES MNUFACTURED AFTER SEPTEMBER '05. THE FIXING OF THE GEAR ON THE CRANKSHAFT IS MADE BY A SPACER WITH AN "OR" WHICH IS PUSHED AGAINST GEAR BY THE IGNITION ROTOR.</u></p>	 <p>Fig.18</p>  <p>Fig.19</p>
<p>5. <u>INSTALLING THE STARTER</u></p> <p>- PLACE STARTER IN THE CRANKCASE SEAT (see Fig.20). OIL "O'RING" BEFORE INSERTING. CHECK THAT THE CLAMP FIXING THE STARTER CABLE IS IN PLACE.</p> <p>N°2 ALLEN SCREWS M6x35 TORQUE AT A 8÷10 Nm (70 ÷ 90 in-lb).</p> <p> (5mm ALLEN SCREW – T TYPE)</p>	 <p>Fig.20</p>
<p>6. <u>INSTALLING THE GEAR COVER</u></p> <p>- PLACE GASKET ON CRANKCASE (see Fig.21).</p>	 <p>Fig.21</p>



ATTENTION:
CHECK PLAY BETWEEN RING GAPS TO BE WITHIN 0.25 AND 0.30mm.
PLAY MUST BE CONTROLLED WITH A THICKNESS GAUGE AND INSERTING THE PISTON RING IN THE CYLINDER (see Fig.26).
REPLACE PISTON RING WHEN PLAY EXCEEDS 0.4mm.



ATTENTION:
PLAY BETWEEN PISTON AND LINER MUST BE BETWEEN 0.11-0.12mm.
IF PLAY EXCEEDS 0.14mm REPLACE PISTON.

FOLLOW INSTRUCTIONS ON THE ATTACHMENT FOR PROPER MATCHING. PISTONS TO BE MEASURED AT 17.5mm FROM BOTTOM (see attachment). ALWAYS REPLACE PISTON AND PISTON RING.

- INSERT CAGE IN THE CON-ROD HOLE (LITTLE END) AND PISTON PIN WITH SPECIAL PISTON PIN PUNCH (P.N. 10200) (see Fig.27).
 MAKE SURE THAT ARROW ON THE TOP OF PISTON IS TURNED TOWARDS EXHAUST. AS GENERAL RULE THE PISTON PIN MUST BE INTRODUCED BY HAND AND FORCED IN THE HOLE.
 IF THE PISTON PIN IS LOOSE IN SEAT, REPLACE IT WITH A PISTON PIN WITH HIGHER DIAMETER.

- INSTALL CIRCLIP ON SPECIAL TOOL (P.N. 10120). GREASE TOOL TO KEEP CIRCLIP IN POSITION. (see Fig.28).

- INSTALL CIRCLIPS (see Fig.29). CHECK CIRCLIPS TO BE IN SEAT.



Fig.26



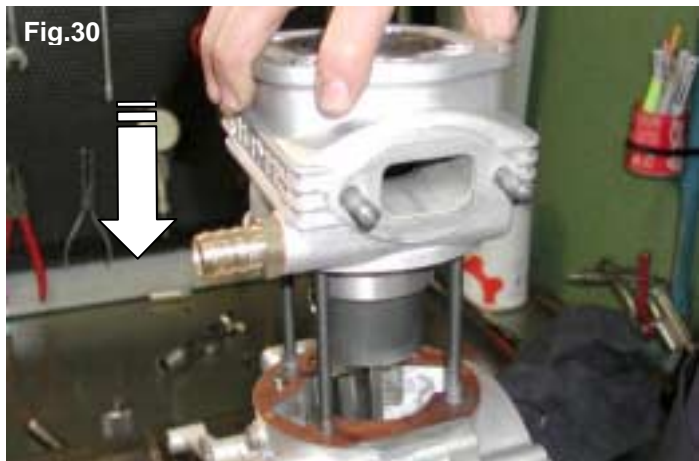



Fig.27



Fig.28



Fig.29

<p>9. <u>INSTALLING THE CYLINDER</u></p> <ul style="list-style-type: none"> - INSTALL A NEW GASKET ON THE CYLINDER BASE. OIL CYLINDER LINER AND PISTON. INSTALL CYLINDER (see Fig.30). <ul style="list-style-type: none"> - INSTALL THE O'RINGS: (see Fig.31) - ON INTERNAL OF CYLINDER - ON EXTERNAL OF CYLINDER - ON TIE-RODS 	<p>Fig.30</p>  <p>Fig.31</p> 
<p>10. <u>ASSEMBLING THE CYLINDER HEAD</u></p> <ul style="list-style-type: none"> - CLEAN COMBUSTION CHAMBER FROM DEPOSITS. <p>⚠ ATTENTION: <u>DO NOT SCRATCH COMBUSTION CHAMBER.</u></p> <ul style="list-style-type: none"> - INSTALL HEAD (see Fig.32). N°4 SCREWS M8 WITH WASHERS CROSS PATTERN ASSEMBLY TORQUE AT 18÷22 Nm (160 ÷ 190 in-lb). <p> (TORQUE WRENCH WITH 13mm BUSH)</p>	<p>Fig.32</p> 
<p>11. <u>INSTALLING THE IGNITION</u></p> <ul style="list-style-type: none"> - INSERT KEY ON SHAFT (see Fig.33). 	<p>Fig.33</p> 

- INSTALL ROTOR ON SHAFT
(see Fig.34).



Fig.34

- INSTALL PISTON FITTING (P.N. 10271)
ON HEAD AND INSERT WASHER AND M10
NUT ON SHAFT.

TORQUE AT 20÷26 Nm (175÷230 in-lb) (see
Fig.35).

(17mm SOCKET WRENCH)



Fig.35

- INSTALL STATOR
N°4 ALLEN SCREWS M5x25 (see Fig.36).
TORQUE AT 5÷6 Nm (45 ÷ 50 in-lb).

(4mm ALLEN WRENCH-T TYPE)

- REMOVE PISTON FITTING FROM HEAD



Fig.36

12. INSTALL STARTER COUNTERSHAFT

- GREASE BOTH COUNTERSHAFT ENDS
AND INSERT COUNTERSHAFT IN
CRANKCASE SEAT
(see Fig.37).



Fig.37

- INSTALL COUNTERSHAFT COVER

N°3 ALLEN SCREWS M6x25 (see Fig.38).
TORQUE AT 6÷8 Nm (50 ÷ 70 in-lb).

(5mm ALLEN WRENCH – T TYPE)



Fig.38

BEFORE ASSEMBLING THE CLUTCH, WASH WITH DILUENT THE SHAFT TAPER, THE STARTER RING HOLE, THE CLUTCH BODY AND THE CLUTCH DRUM.

13. ASSEMBLING THE CLUTCH

- INSTALL STARTER RING ON CLUTCH BODY BY MATCHNG THE 3 HOLES AND THE DRAGGING PIN (see Fig.39).



Fig.39

- INSTALL N°3 SCREWS M6x12
APPLY LOCTITE ON THE THREADS (Loctite 243) .
TORQUE AT 9÷11 Nm (80 ÷100 in-lb)
(see Fig.40).



(10mm SOCKET TYPE - TORQUE METER)



Fig.40

⚠ ATTENTION:
MAKE SURE TO ALWAYS INSTALL THE Ø 7mm DRAGGING PIN, AS OTHERWISE THE EVENTUAL KICKBACKS COULD BREAK THE SCREWS.

- APPLY "LOCTITE 641" ON THE TAPER SHAFT FOR COAXIAL LOCKINGS (see Fig.41).



Fig.41

- INSTALL STARTER RING WITH CLUTCH BODY ON CRANKSHAFT (see Fig.42).



Fig.42

- INSTALL STARTER RING FIXING NUT USE CLUTCH WRENCH (P.N. 10270). TORQUE AT 100÷110 Nm (885 ÷ 970 in- lb) (see Fig.43).

(30mm SOCKET TYPE - TORQUE METER)



⚠ ATTENTION:
TURN COUNTERCLOCKWISE AS NUT HAS LEFT THREAD.

NOTE:
DO NOT USE THE PISTON FITTING TOOL TO PREVENT THE SHAFT FROM TURNING.



Fig.43

- INSTALL INTERNAL WASHER (see Fig.44).

⚠ ATTENTION:
INSTALL WASHER WITH BEVEL TOWARDS SHAFT.



Fig.44

- INSTALL ROLLER CAGE, CLEAN AND GREASE IT BEFORE INSTALLING ON THE SHAFT.

(see Fig.45).



Fig.45

- INSTALL CLUTCH DRUM AND EXTERNAL WASHER (see Fig.46).

 **ATTENTION:**
INSTALL WASHER WITH BEVEL TOWARDS SHAFT.



Fig.46

- INSTALL PISTON FITTING (P.N. 10271) TO PREVENT SHAFT FROM TURNING AND TIGHTEN THE M10 NUT FIXING THE DRUM

(see Fig.47).
TORQUE AT 30÷40 Nm (265 ÷ 350 in-lb)

(12 POINT WRENCH -17mm)



- REMOVE THE PISTON FITTING









Fig.47

- INSTALL CLUTCH COVER N°3 ALLEN SCREWS M6x25 (see Fig.48).
TORQUE AT 8÷10 Nm (70 ÷ 90 in-lb)

(5mm ALLEN WRENCH – T TYPE)

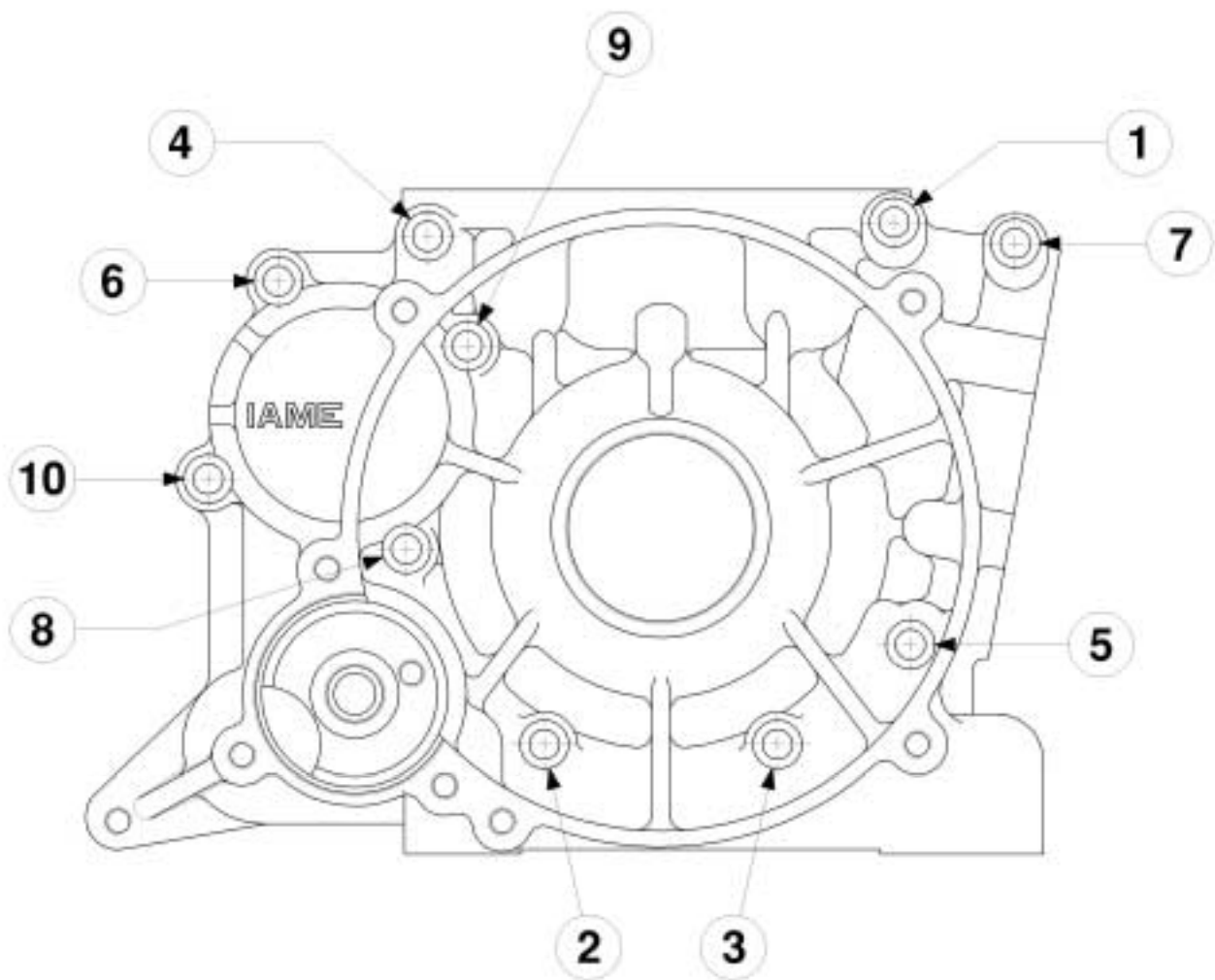

Fig.48

	<p>- FIX THE GROUND CABLE ON THE CRANKCASE</p> <p>ALLEN SCREW M6x12 (see Fig.49). TORQUE AT 8÷10 Nm (70÷ 90 in-lb)</p> <p>(5mm ALLEN WRENCH – T TYPE)</p>	 <p>Fig.49</p>
<p>14.</p> 	<p><u>INSTALLING THE REED GROUP</u></p> <p>- INSTALL INTERNAL GASKET</p> <p>- INSTALL THE REED GROUP (SO THAT "IAME" IS TOWARDS UPPER SIDE) (see Fig.50).</p> <p><u>! ATTENTION:</u> <u>CHECK BEFORE, THE STATUS OF REED PETALS.</u> <u>IF REED PETALS SHOW SIGNS OR IF, LOOKING COUNTERLIGHT THEY DO NOT MATCH PERFECTLY, REPLACE THEM.</u> <u>(REMOVE N° 8 SCREWS AND PLACE REED PETALS WITH CUT ON THE BOTTOM TO BE TOWARDS RIGHT SIDE).</u></p> <p>- INSTALL THE EXTERNAL GASKET. BE SURE THAT THE HOLE ON THE GASKET MATCHES WITH THE HOLE ON THE INLET MANIFOLD.</p> <p>- INSTALL THE INLET MANIFOLD AND CARBURETOR GASKET. N°4 ALLEN SCREWS M6X25 (see Fig.51). TORQUE AT 8÷10 Nm (70 ÷ 90 in-lb) (5mm ALLEN WRENCH – T TYPE)</p>	 <p>Fig.50</p>  <p>Fig.51</p>
	<p>15. <u>INSTALLING THE EXHAUST HEADER</u></p> <p>- PLACE GASKET AND INSTALL THE EXHAUST HEADER N°2 NUTS M8 WITH WASHERS (see Fig.52). TORQUE AT 18÷22 Nm (160 ÷ 190 in-lb)</p> <p>(12 POINT WRENCH 13mm)</p>	 <p>Fig.52</p>

NOMINAL SIZE	Q.TY	FASTENER NAME	WRENCH	VALUES(Nm)	VALUES(in•lb)
M14 x 1.25	1	Spark plug	Hex.20,8	20 – 26	175 – 230
M8 x 1.25	4	Head and cylinder nut	Hex. 13	18 – 22	160 – 190
M8 x 1.25	2	Exhaust nut	Hex. 13	18 – 22	160 – 190
M6 x 1	4	Reed group screw	Allen 5	8 – 10	70 – 90
M6 x 1	2	Carb. fixing stud-bolt	Allen 5	8 – 10	70 – 90
M5 x 0.8	4	Ignition stator fixing screw	Allen 4	5 – 6	45 – 50
M10 x 1	1	Ignition rotor fixing nut	Hex. 17	20 – 26	175 – 230
M6 x 1	3	Countershaft support screw	Allen 5	6 – 8	50 – 70
M6 x 1	2	Starter fixing screw	Allen 5	8 – 10	70 – 90
M6 x 1	3	Clutch cover fixing screw	Allen 5	8 – 10	70 – 90
M10 x 1	1	Clutch drum holding nut	Hex. 17	30 – 40	265 – 350
M20 x 1	1	Starter ring fixing nut	Hex. 30	100–110	885 – 970
M5 x 0.8	4	Engine sprocket fixing screw	Allen 3	6 – 8	50 – 70
M6 x 1	3	Clutch fixing screw	Hex. 10	9 – 11	80 – 100
M6 x 1	10	Crankcase fixing screw	Allen 5	8 – 10	70 – 90
M6 x 1	7	Gears cover fixing screw	Allen 5	8 – 10	70 – 90
M5 x 0.8	1	Bal. shaft bearing fix. screw	Allen 3	6 – 8	50 – 70
M6 x 1	2	Coil fixing nut	Hex. 10	8 – 10	70 – 90
M6 x 1	2	Coil/starter ground. fix. screw	Allen 5	8 – 10	70 – 90
M10 x 1	2	Oil charge/discharge plug	Hex. 17	12 – 15	105 – 130

CROSS PATTERN LOCKING ORDER ON CRANKCASE



MAIN PRESCRIPTIONS

CRANKSHAFT

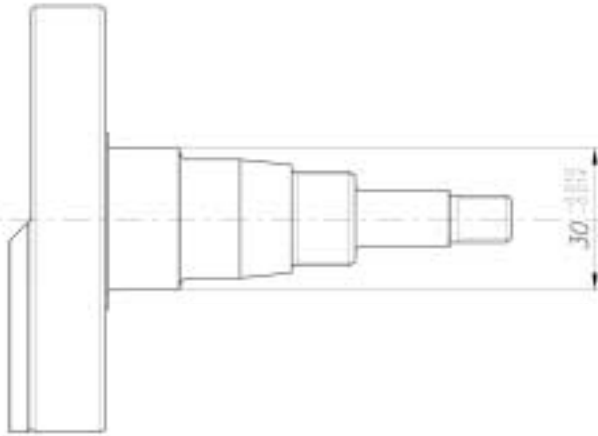

- Bearing seat diameter on new engine

Refer to the attached table to determine wear status of the crankshaft halves.

MAX ALLOWED OVALIZATION OF CON-ROD BIG-END

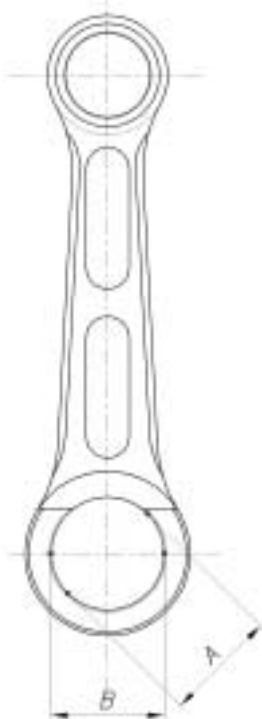

Max. allowed ovalization between A and B on new conrod: 0.002mm

Max. allowed ovalization between A and B on used conrod: 0.01mm

MATCHING THE PISTON

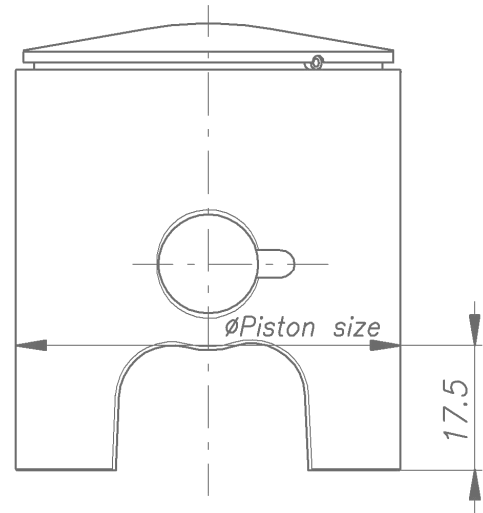

ATTENTION:

Play between piston and liner must be 0.11 ÷ 0.12mm.

if play is higher than 0.14mm replace piston.

Pistons are measured at 17.5mm from bottom.

Size of liner to be matched with piston is marked on top of piston with a green or red dot or with letter V or R.

If the size on piston top is marked with :

-**a green dot or letter V:** add 0.01mm to size marked on the piston to match the liner size.

-**a red dot or letter R:** add 0.02 mm to size marked on the piston to match the liner size.

MATCHING PLAYS - CONROD LOWER END				
CONROD END	Ø CRANK PIN	ØROLLERS ON CAGE	PLAY	
			MIN.	MAX.
$26^{+0.018}_{+0.014}$	$20^{-0.004}_{-0.008}$	$3^0_{-0.002}$	0.018	0.030

MATCHING PLAYS - CONROD UPPER END					
CONROD END	Ø PISTON PIN		ØROLLERS ON CAGE	PLAY	
	RED	WHITE		MIN.	MAX.
	$18^{+0.016}_{+0.012}$	$14^{+0.002}_0$	$14^0_{-0.002}$	$2^0_{-0.002}$	0.010
		$14^{-0.002}_{-0.004}$		0.012	0.022
				0.014	0.024

RECOMMENDATIONS TO BE FOLLOWED WHEN INSTALLING THE GEARS

1- ROTATE CRANKSHAFT AND BALANCE SHAFT SO THAT REFERENCE NOTCHES ARE IN UPPER POSITION.

YES



NO

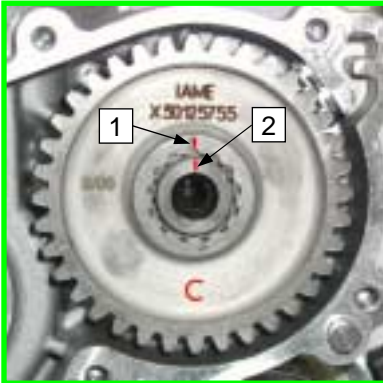

2- INSTALL GEAR ON BALANCE SHAFT SO THAT THE "C" LETTER CAN BE READ ON THE SURFACE AND ALIGN THE MARKED GEAR TOOTH SPACE (1) WITH THE MARKED TOOTH ON BALANCE SHAFT (2).

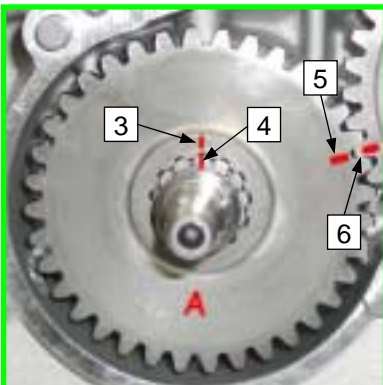

3- INSTALL GEAR ON CRANKSHAFT SO THAT THE "A" LETTER CAN BE READ ON THE SURFACE AND ALIGN THE MARKED GEAR TOOTH SPACE (3) WITH THE MARKED TOOTH ON THE CRANKSHAFT (4). FIT THE TWO GEAR TEETH ALIGNING THE NOTCHES ON TEETH (5) AND (6).

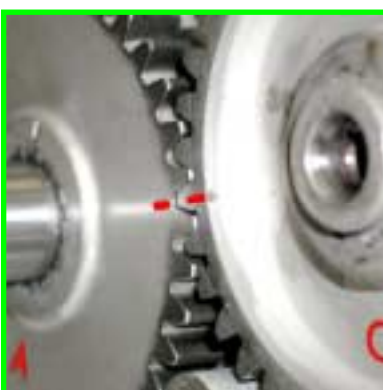

4- CHECK THAT THE GEAR SURFACES ARE ON THE SAME PLANE
IF THERE IS A STEP BETWEEN THE TWO GEARS, REPEAT THE INSTALLATION.

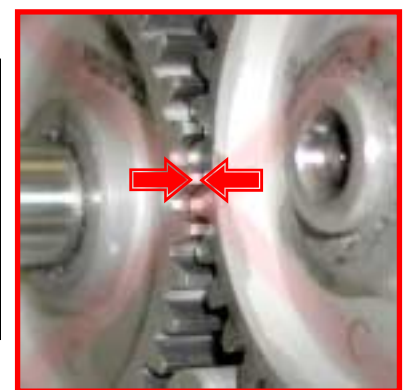

5- BEFORE INSTALLING THE RETAINING RINGS, CHECK THE POSITION OF GEARS AND THE ALIGNMENT OF ALL REFERENCE NOTCHES.



OVERHAUL TOOL LIST

SPECIFIC TOOLS AVAILABLE AT IAME

<u>DESCRIPTION</u>	<u>P.N.</u>
• PISTON FITTING	10271
• CLUTCH LOCKING WRENCH	10270
• CLUTCH DISASSEMBLY TOOL	10272-C
• PISTON PIN FITTING	10200
• PISTON CIRCLIP ASSEMBLY TOOL	10120
• CRANKSHAFT ASSEMBLY KIT	10110B-C
<i>It includes:</i>	
- crankpin bush	10150A
• CRANKSHAFT DISASSEMBLY KIT	10100A-C2
<i>It includes:</i>	
- crankshaft plate	10104A
- crankshaft support	10100
- crankpin pusher	10107
- crankshaft insert	10106
• BEARING DISASSEMBLY TOOL	10291
• EXTERNAL BALANCE SHAFT BEARING ASSY/DISASSY TOOL	10293
• BEARING ASSEMBLY TOOL	10290
• INTERNAL BALANCE SHAFT BEARING ASSY/DISASSY TOOL	10292
• OIL SEAL ASSEMBLY TOOL (without crankshaft)	10295
• OIL SEAL ASSEMBLY TOOL (with installed crankshaft)	10295A
• GEAR COVER OIL SEAL ASSEMBLY TOOL	10296

- | |
|---|
| <ul style="list-style-type: none"> • ENGINE FIXING TOOL ON BENCH VICE (see attached drawing) |
|---|



STANDARD TOOLS

• ALLEN WRENCH- T TYPE	4mm
• ALLEN WRENCH- T TYPE	5mm
• ALLEN WRENCH	12mm
• HEXAGON RING WRENCH – T TYPE	13mm
• 12 POINT WRENCH	10mm
• 12 POINT WRENCH	13mm
• 12 POINT WRENCH	14mm
• 12 POINT WRENCH	17mm
• 12 POINT WRENCH	19mm
• HEXAGON RING WRENCH	27mm
• HEXAGON RING WRENCH	30mm
• SPARKPLUG WRENCH	20.8mm
• SCREWDRIVER WITH ROUNDED EDGES	
• PLASTIC Mallet	
• COPPER Mallet	
• TORQUE METER	10/13/30mm
• PLIERS FOR RETAINING RINGS	
• 5 MeT PRESS	

WEAR STATUS EVALUATION TABLE - BEARINGS AND HALFCRANKSHAFT

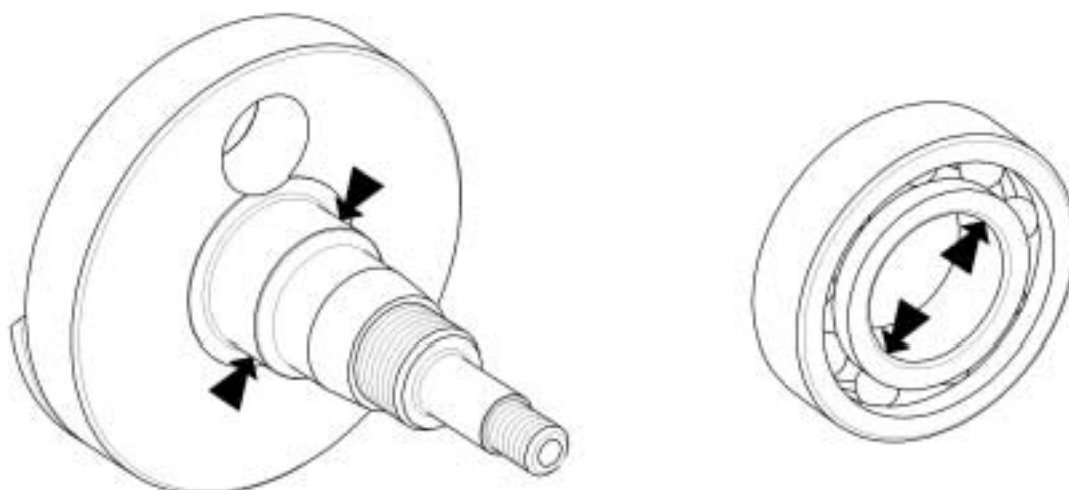

NOTE:

ALWAYS CHECK DIMENSIONS IN DIFFERENT POINTS ON CIRCUMFERENCE, LOOKING FOR EVENTUAL OVALIZATIONS

On the following Table are shown the ovalization limits above which replacement is required

MEASURED PART (MEASURING INSTRUMENT)	LIMITS
CRANKSHAFT – BEARING SEAT (MICROMETER 25÷50 1/100)	MIN. Ø29.96
BALANCE SHAFT – EXTERNAL BEARING SEAT (MICROMETER 0÷25 1/100)	MIN. Ø24.96
BALANCE SHAFT – INTERNAL BEARING SEAT (MICROMETER 0÷25 1/100)	MIN. Ø14.95
CRANKSHAFT BEARINGS (1/100 BORE GAUGE WITH CHECK RING Ø30)	* MAX. Ø30.03
BALANCE SHAFT - EXTERNAL BEARING (1/100 BORE GAUGE WITH CHECK RING Ø25)	* MAX. Ø25.03
BALANCE SHAFT – INTERNAL BEARING (BORE GAUGE 1/100 WITH CHECK RING Ø15)	* MAX. Ø15.03

*  **ATTENTION:**

THE MEASURED VALUE ON THE BEARING MUST ALWAYS BE COMPARED WITH THE SEAT VALUE (ON SHAFT AND/OR BALANCE SHAFT), TO CHECK THAT PLAY, BETWEEN SHAFT AND BEARING DOES NOT EXCEED THE LIMIT VALUE OF 0.05mm.

FIXING TOOL ON VICE BENCH

